

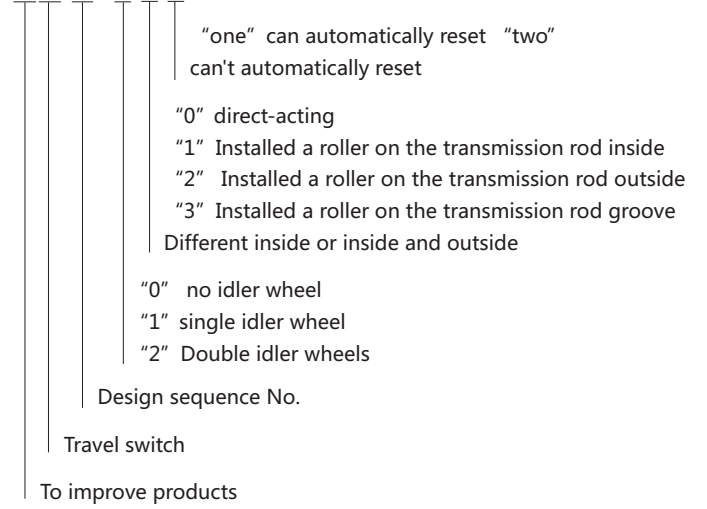

2. Type designation

YBLX-19/□□□



Contact type

YBLX-19 Travel Switch

1. General

Apply to AC-15 50Hz/60Hz, Ue380V, Ie0.79A DC-13 Ue220V Ie0.1A and the following electrical lines, as stroke control of motion mechanism, motion direction or speed transformation, automatic machine tool control, limiting action of motion mechanism and control the trip or procedures used.

Standard: GB/T 14048.5, IEC 60947-5-1, won the Certification of CCC National mandatory product.

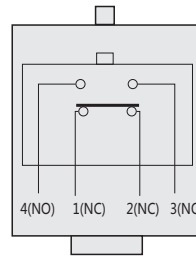

3. Technical data

Table 1

level of protection	IP52
Conventional thermal current	5A
Rated voltage	AC 380V ; DC220V
Rated control current	AC 0.79A ; DC0.1A
Frequency of operation	20t/min
Installation category	II
Pollution degree	class3
Insulation voltage Ui	415V
Rated impulse withstand voltage Uimp	2.5KV
Ambient temperature	-5°C~+40°C
Relative humidity	≤90%(20°C)
Altitude of sea level	≤2000m
Comply with a standard	GB/T 14048.5 IEC 60947-5-1

Table 2

Type	YBLX-19/001	YBLX-19/111 YBLX-19/121 YBLX-19/131	YBLX-19/212 YBLX-19/222 YBLX-19/232
Max of actuating force	16N	20N	25N
max of Operation range	7mm	45°	80°
Min of overtravel	2mm	15°	-

Table 3

Type	Structure and installation of drive
YBLX-19/001	Plunger
YBLX-19/111	A wheel mounted inside the "-" shaped pivot arm
YBLX-19/121	A wheel mounted outside the "-" shaped pivot arm
YBLX-19/131	A wheel mounted in the groove of the "-" shaped pivot arm
YBLX-19/212	Two roller are installed on internal side of "Cross" shaped rotating arm (Lower left, Lower right)
YBLX-19/222	Two roller are installed on internal side of "Cross" shaped rotating arm (Upper left, Upper right)
YBLX-19/232	Two roller are installed on "Cross" shaped rotating arm, One on the internal side and the other on the external side(Lower left, Upper right)

4. Overall and mounting dimensions

YBLX-19/001

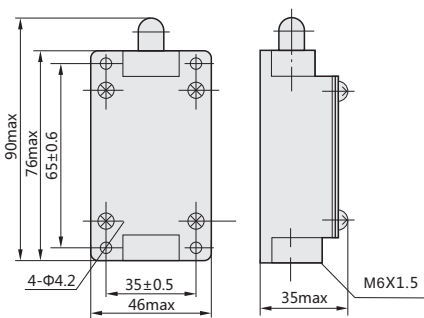

YBLX-19/111

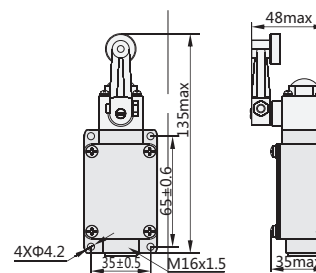

YBLX-19/121

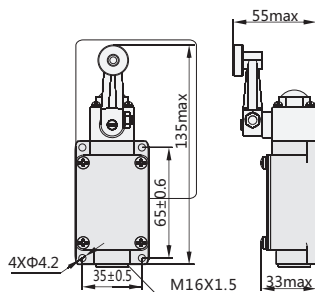

YBLX-19/131

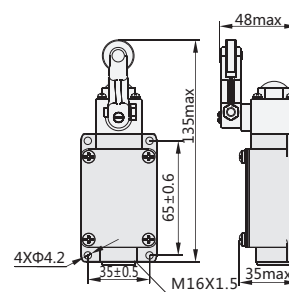

YBLX-19/212,222,232

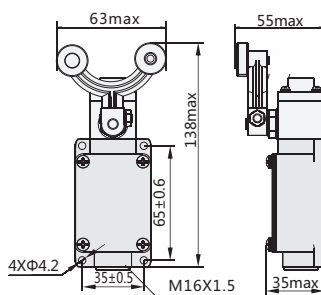

5. Ordering information

Please explain the model of switch, names and numbers when customers order

Such as: YBLX-19/111 Travel switch 100 peaces

User note:

YBLX-19/111, YBLX-19/121, YBLX-19/131 restricted by operating mechanism.

It can not apply to the arm action is greater than 90 degree condition.

Beware of the action angle is too large lead to turn arm rotation and other undesirable phenomena.